

Kompozit Panel Cephe Kaplama Sistemi

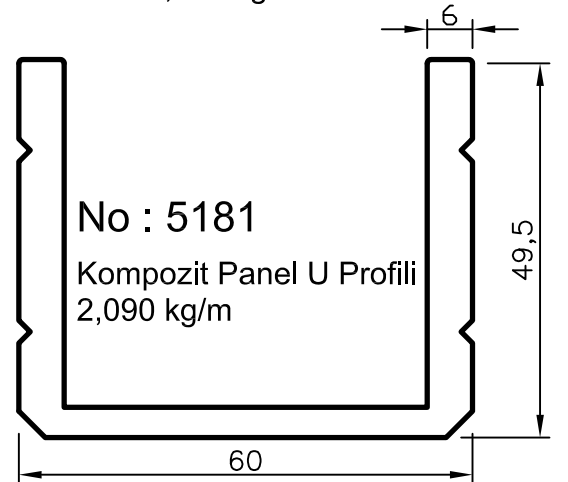

Kompozit Panel Cephe Kaplama Sistemi

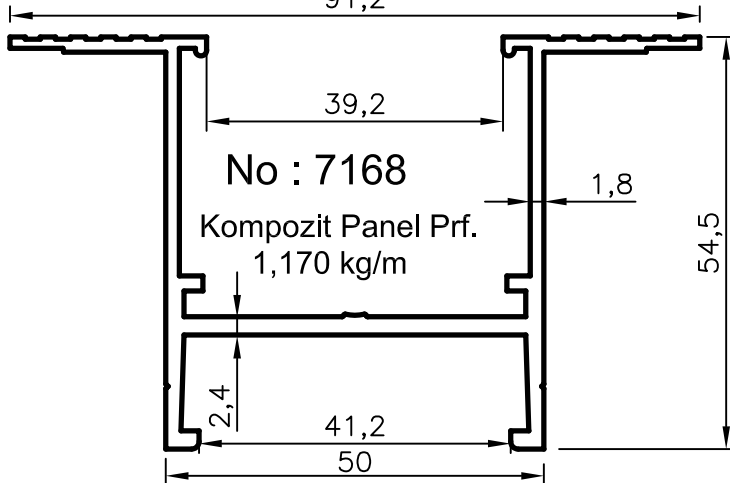
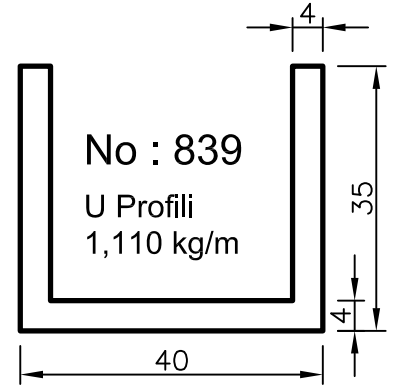
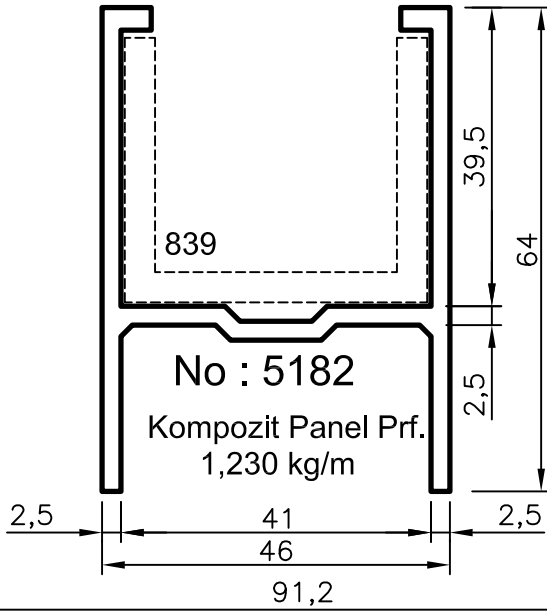
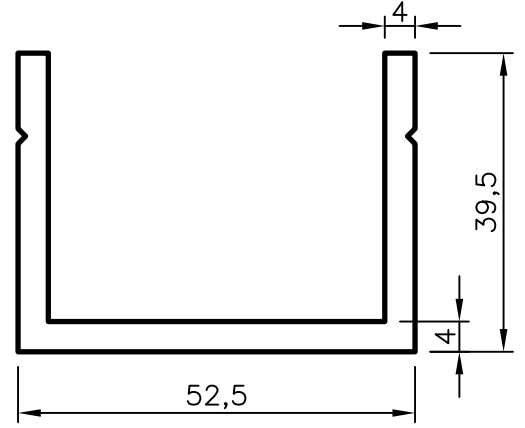
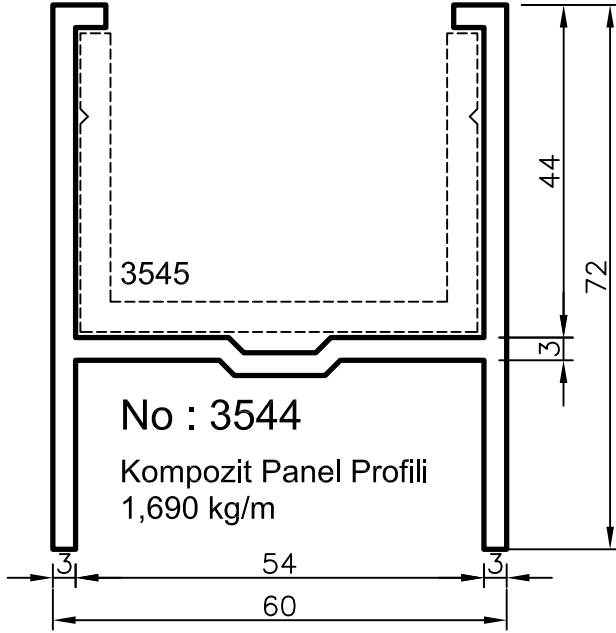
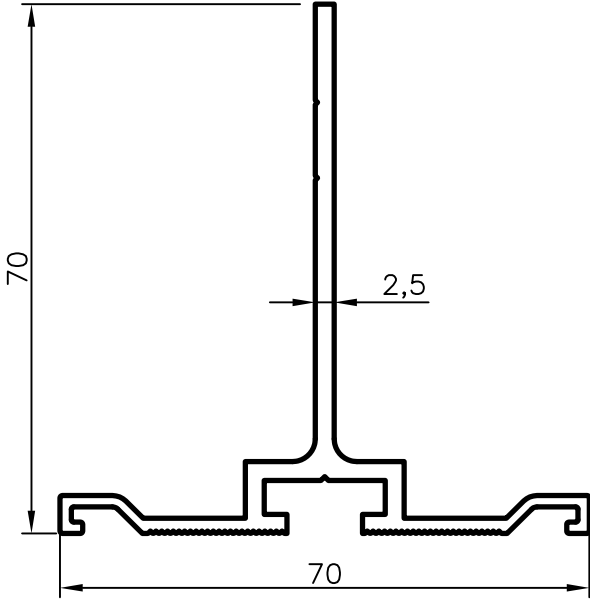

No : 8598

Taşıyıcı Profil
0.910 kg/m

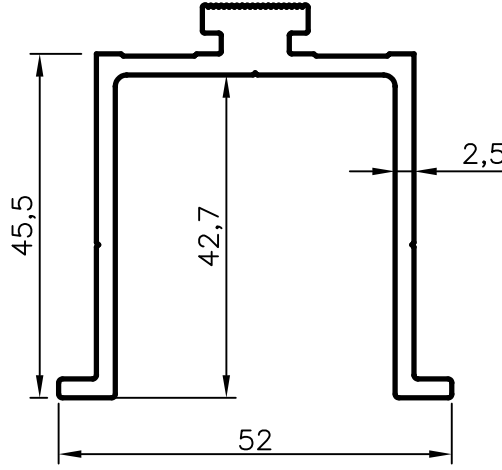

No : 8599

Taşıyıcı Profil
1.160 kg/m
SC-510 (50 tk/pk)

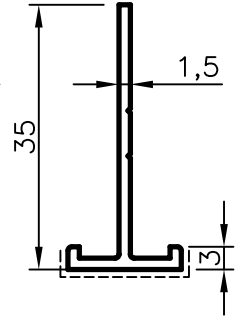

No : 8707

Derz Profil
0.215 kg/m

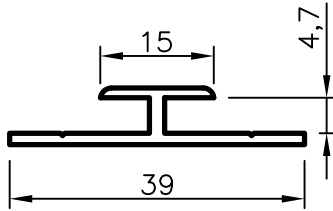

No : 3452

Kompozit Panel
Ek Yeri Profili
0.245 kg/m

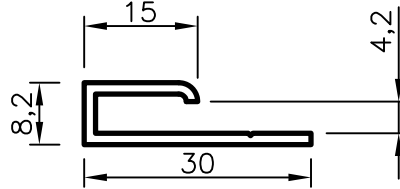

No : 3454

Kompozit Panel
Bitiş Profili
0.205 kg/m

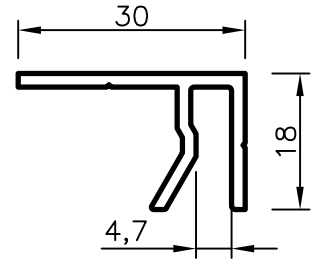

No : 3958

F Profil
Bitiş Profili
0.320 kg/m

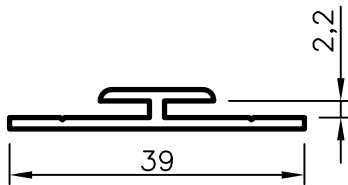

No : 3453

Levha Ek Yeri Profili
0.230 kg/m

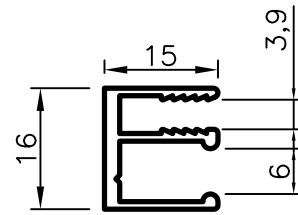

No : 4986

U Profil
0.220 kg/m

Kompozit Panel Cephe Kaplama Sistemi

L BRAKETLER

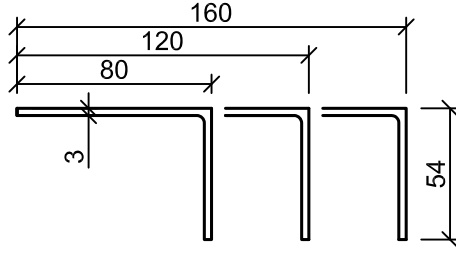

No : 4747

54X80 L

1,075 kg/m

No : 4748

54X120 L

1,400 kg/m

No : 4749

54X160 L

1,725 kg/m

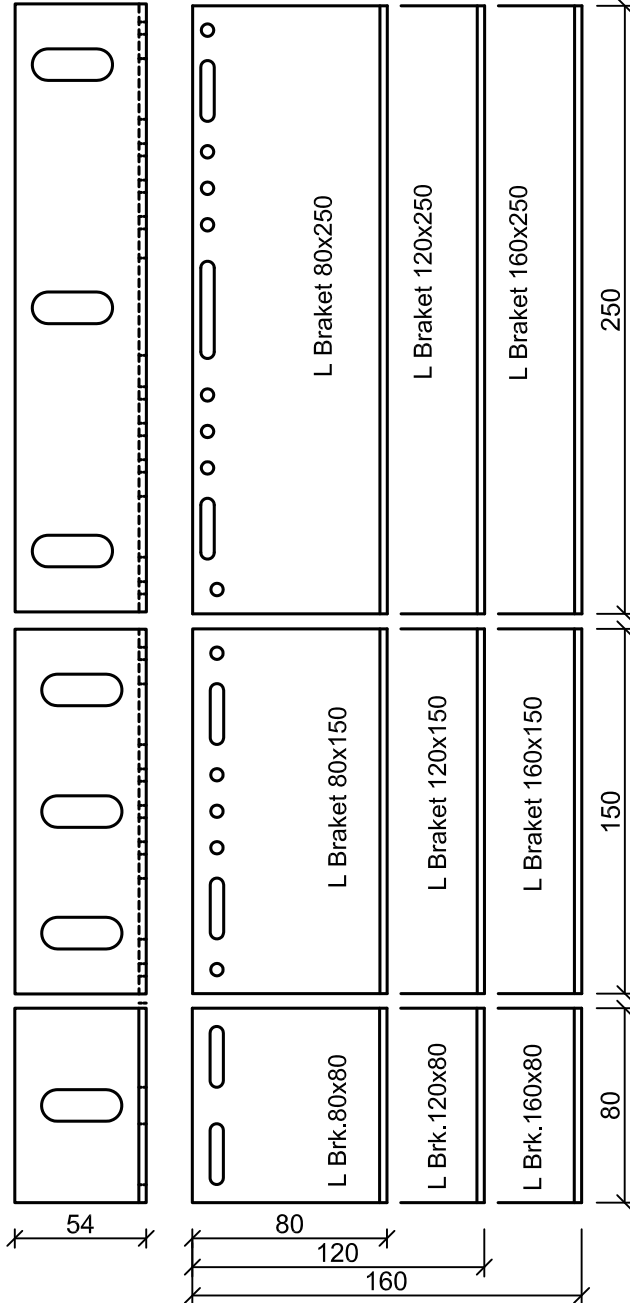

YAN GÖRÜNÜŞ











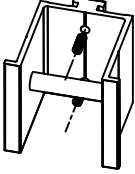

ÖN GÖRÜNÜŞ

ÖLÇEKSİZ

Uyarı: Profil ağırlıklarımız teorik olup; teslim anındaki tartımız geçerlidir.

Kompozit Panel Cephe Kaplama Sistemi

AKSESUAR LİSTESİ

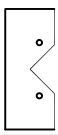
RESİM PICTURE	PARÇA NO PIECE NO	MALZEME MATERIAL	AÇIKLAMA DESCRIPTION	PAKET PACKET
	SC-510		Anahtar geçme askı elemanı " 8598 nolu profille kullanılır."	50 TK/PK
		Alüminyum	54X80X80 L Braket	İstenilen Miktarda
			54X120X80 L Braket	
			54X160X80 L Braket	
			54X80X150 L Braket	
			54X120X150 L Braket	
			54X160X150 L Braket	
			54X80X250 L Braket	
			54X120X250 L Braket	
			54X160X250 L Braket	
	PP110			
			Anahtar geçme kalıbı	1 AD
			V köşe kalıbı	1 AD

Kompozit Panel Cephe Kaplama Sistemi

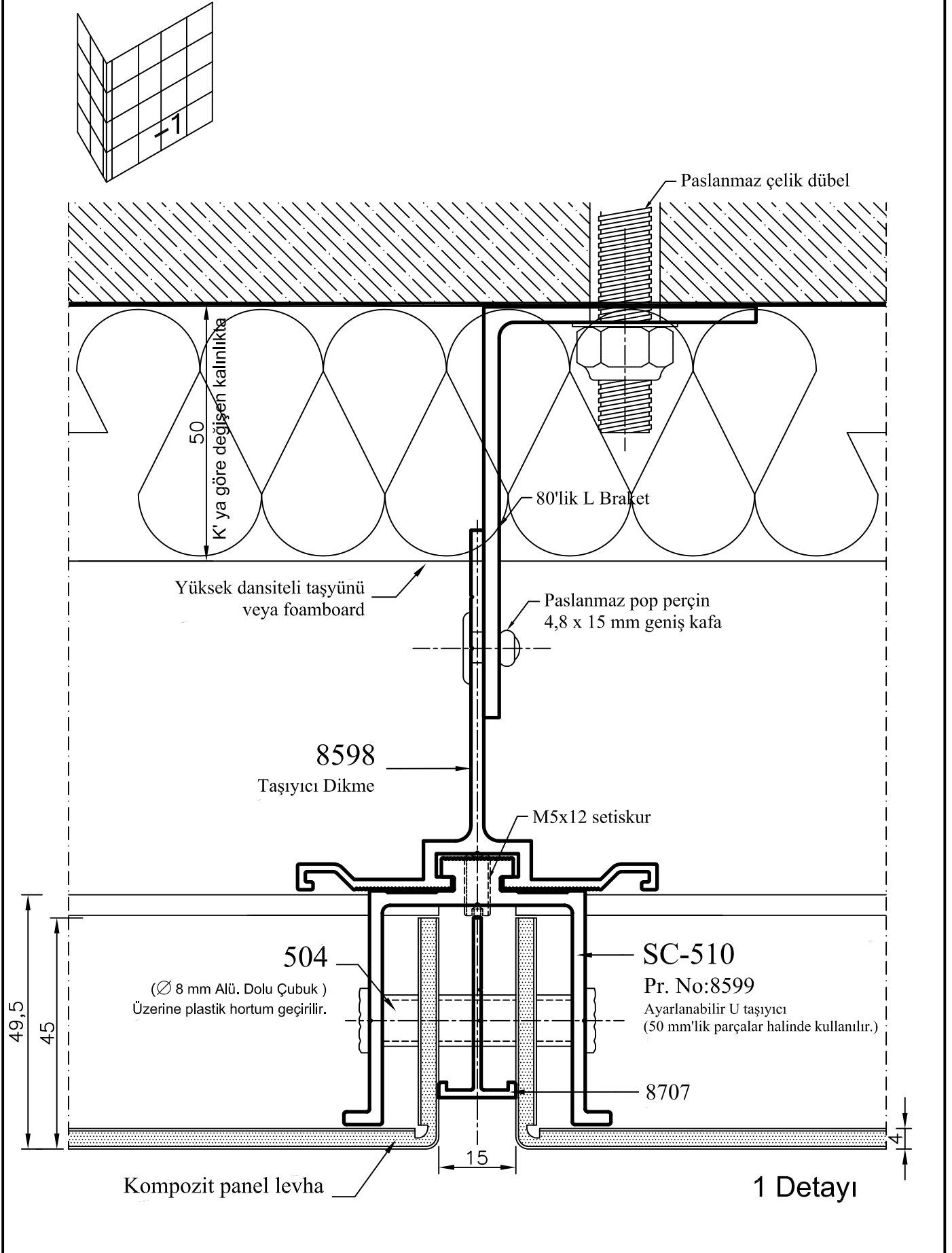

Kompozit Panel Cephe Kaplama Sistemi

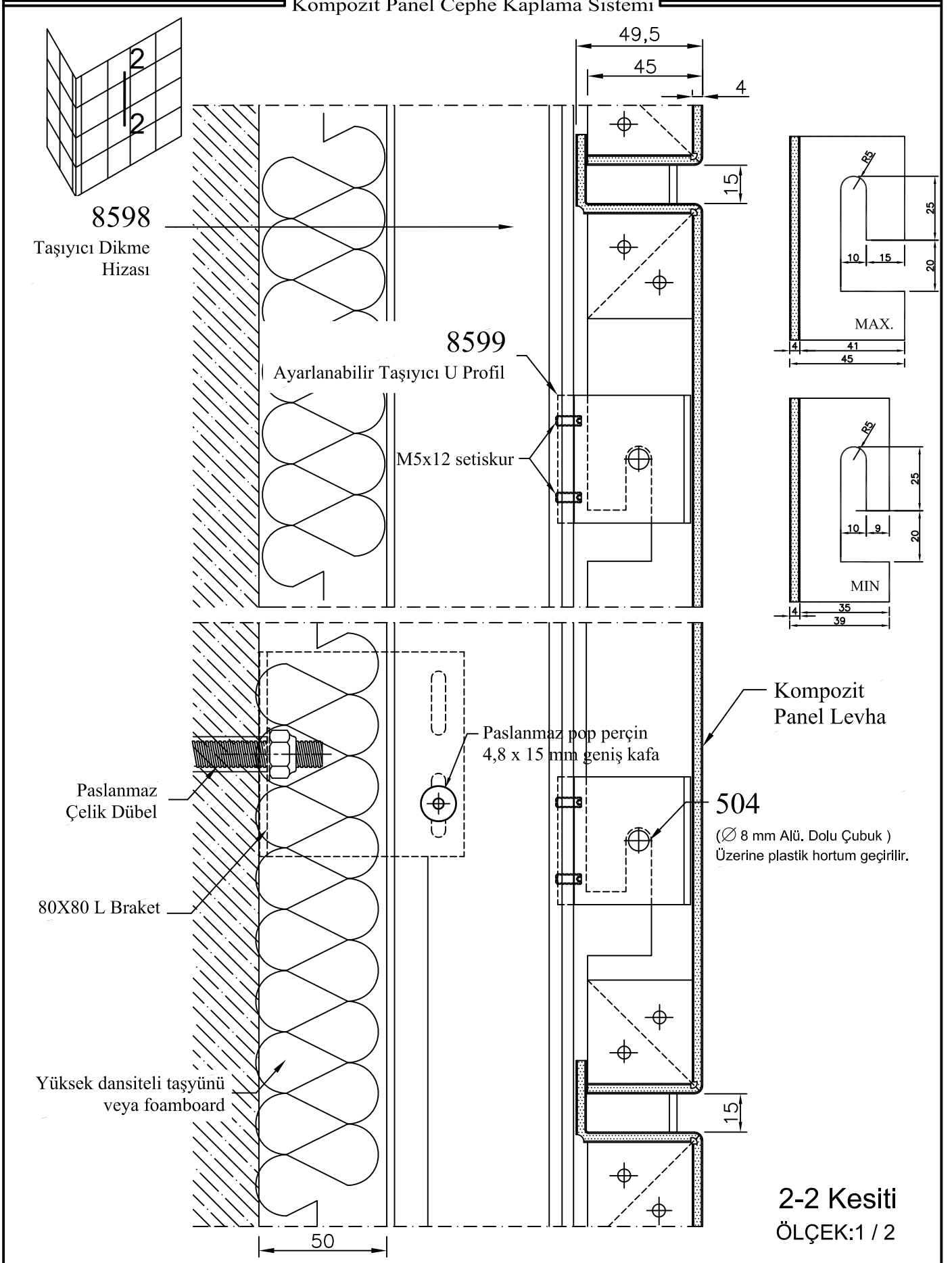

Kompozit Panel Cephe Kaplama Sistemi

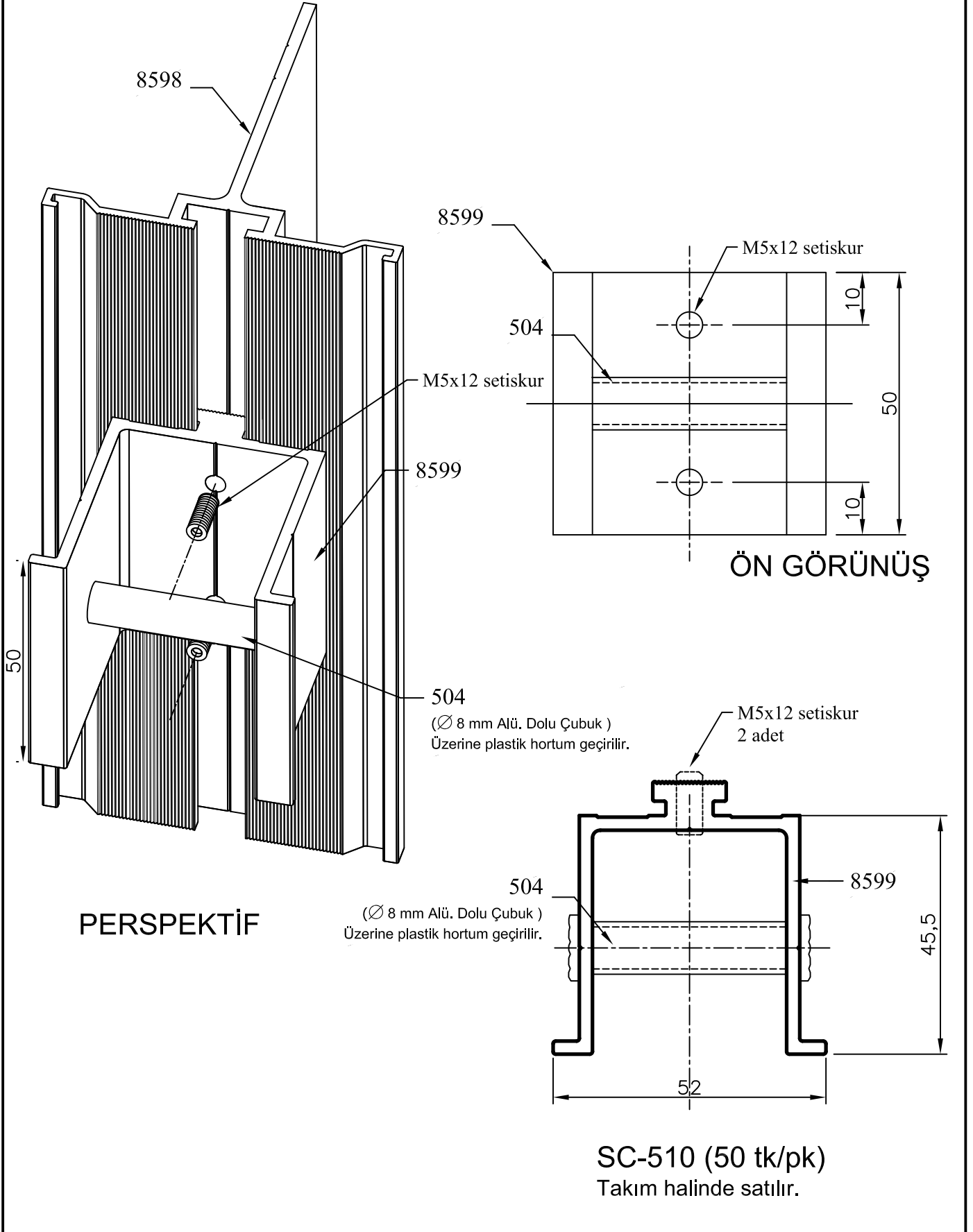

Kompozit Panel Cephe Kaplama Sistemi

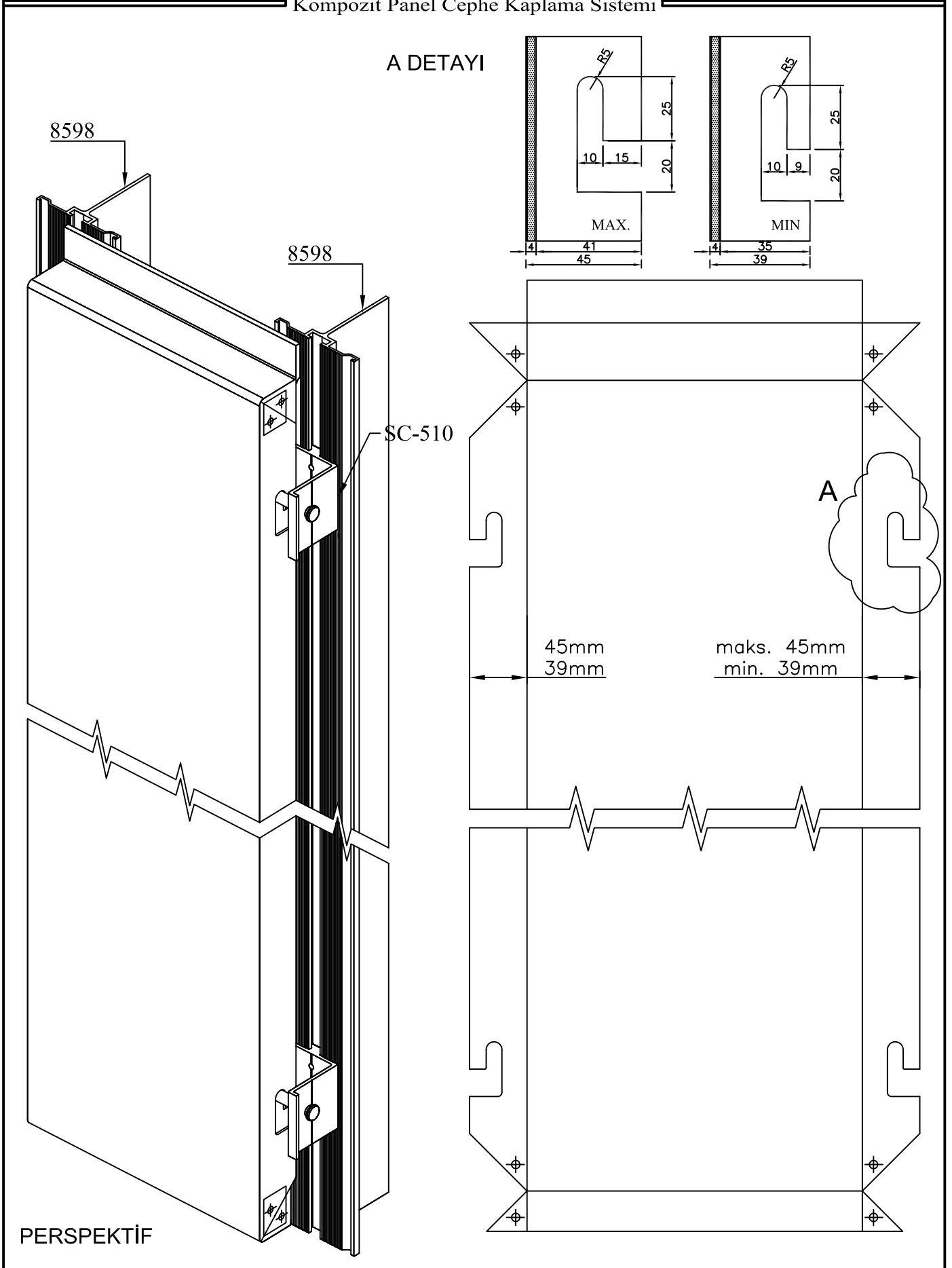

Kompozit Panel Cephe Kaplama Sistemi

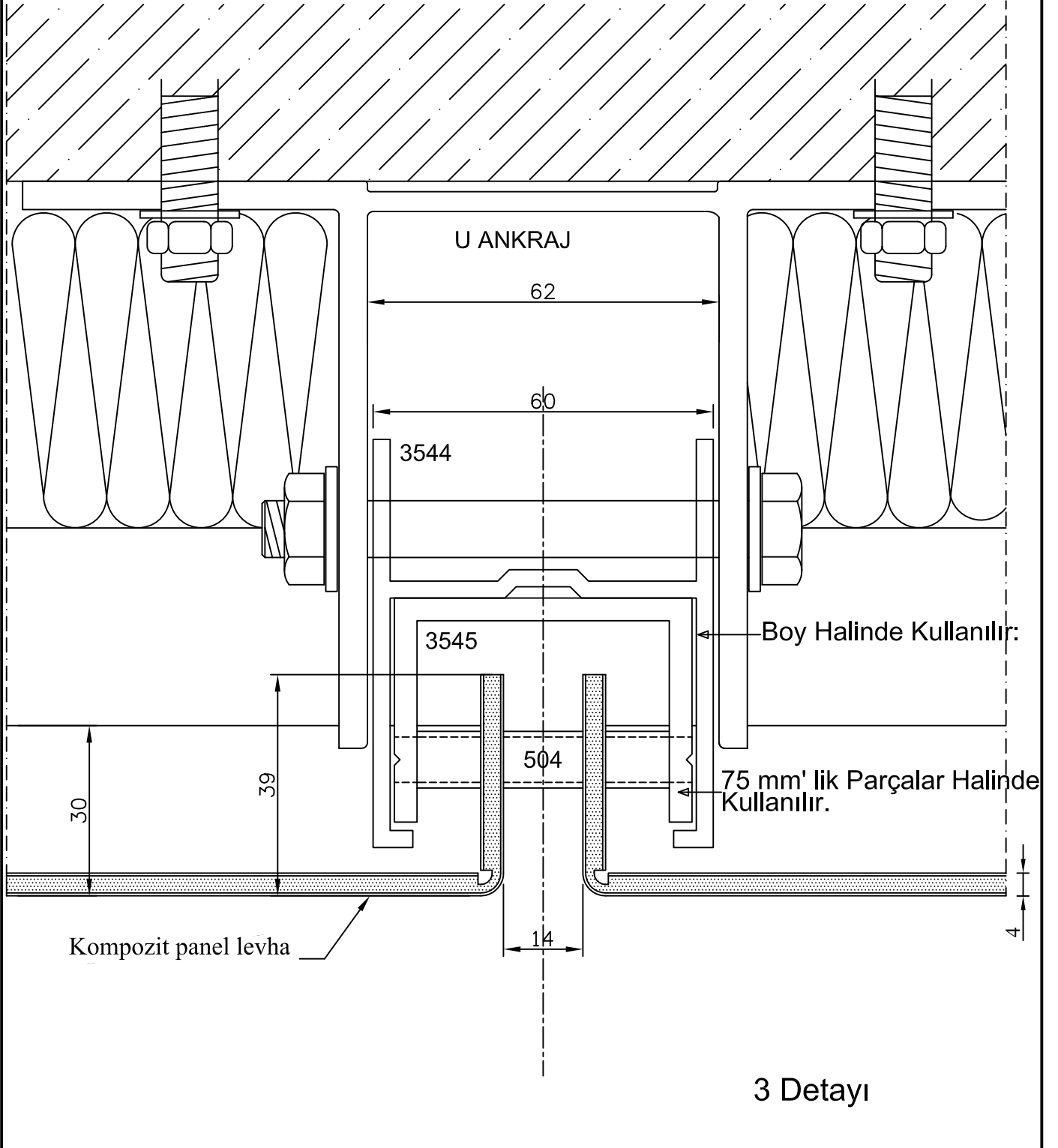
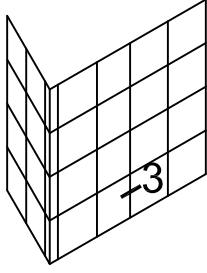

Kompozit Panel Cephe Kaplama Sistemi

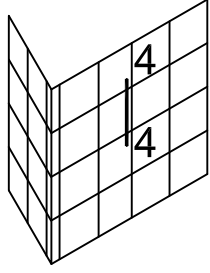

3544
Taşıyıcı Dikme
Hizası

Paslanmaz
Çelik Dübel

U Ankrāj

Yüksek dansiteli taşıyıcı
veya foamboard

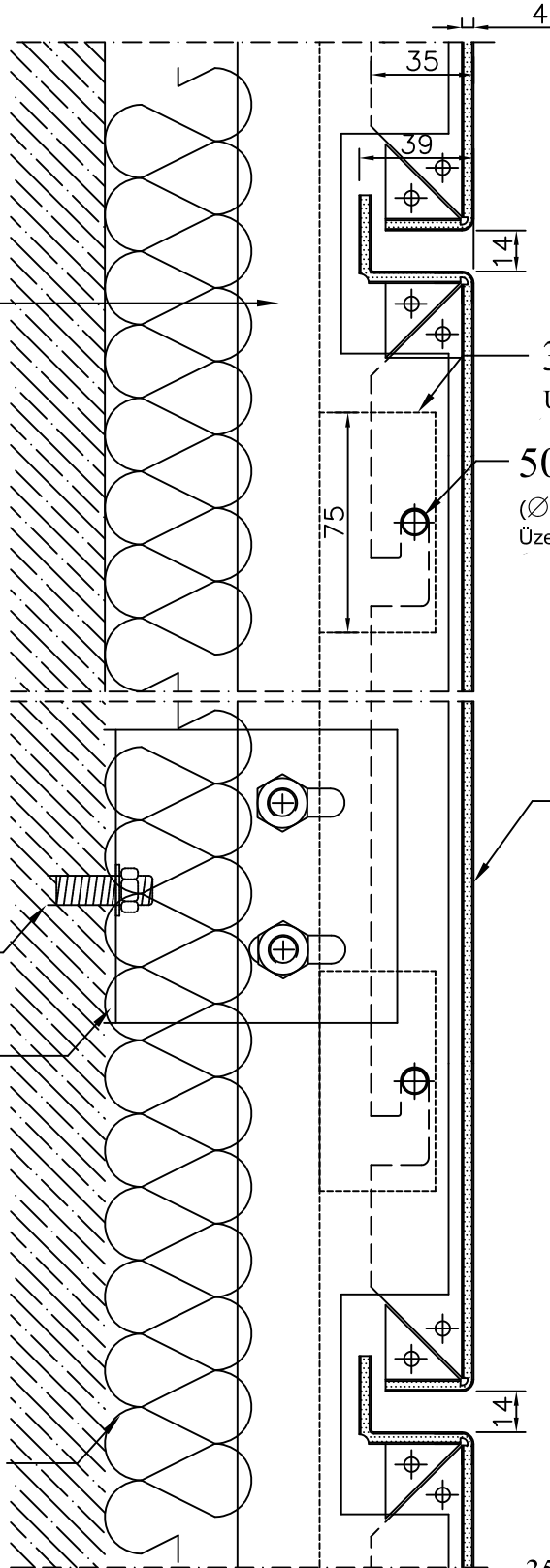

4

35

39

14

3545

U Profil

504

(Ø 8 mm Alü. Dolu Çubuk)
Üzerine plastik hortum geçirilir.

75

14

Kompozit
Panel Levha

14

3545

14

3544

3545

14

3545

3544

504

(Ø 8 mm Alü. Dolu Çubuk)
Üzerine plastik hortum geçirilir.

4-4 Kesiti

Ölçek:1 / 2.5

Kompozit Panel Cephe Kaplama Sistemi

ÖN GÖRÜNÜŞ

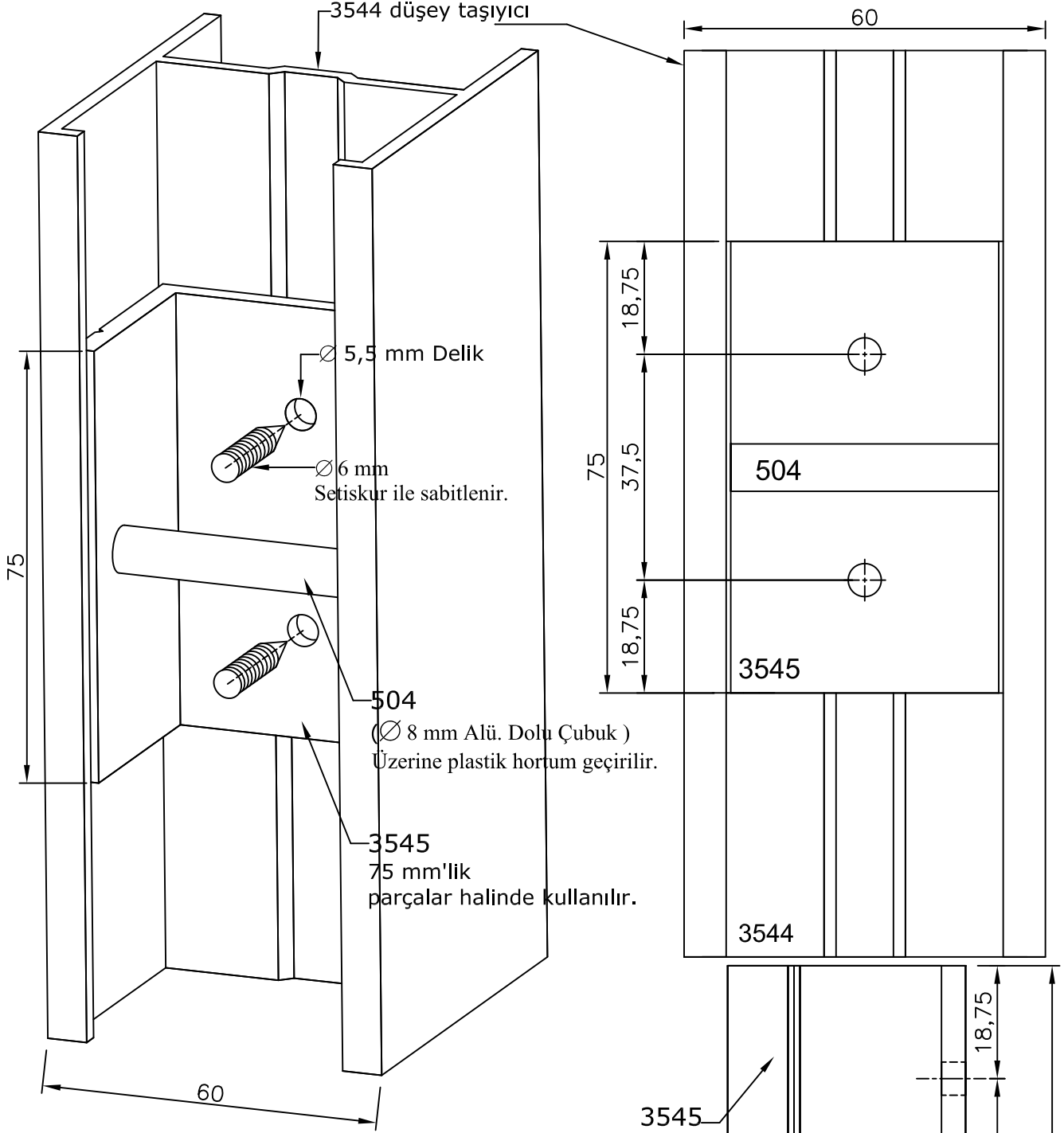

PERSPEKTİF GÖRÜNÜŞ

504
(Ø 8 mm Alü. Dolu Çubuk)
+ Plastik hortum

YAN GÖRÜNÜŞ

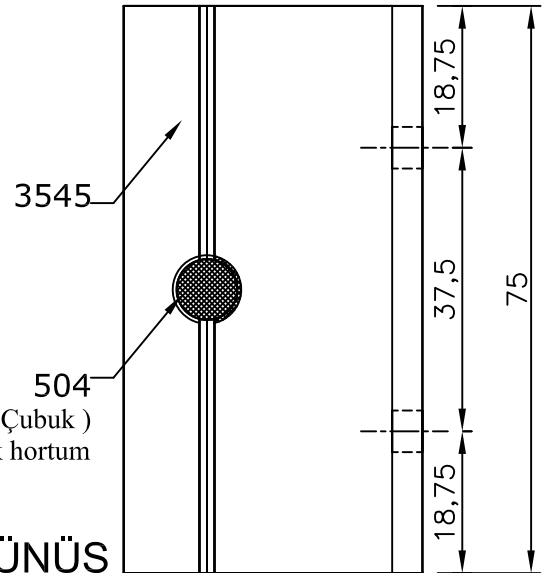

Kompozit Panel Cephe Kaplama Sistemi

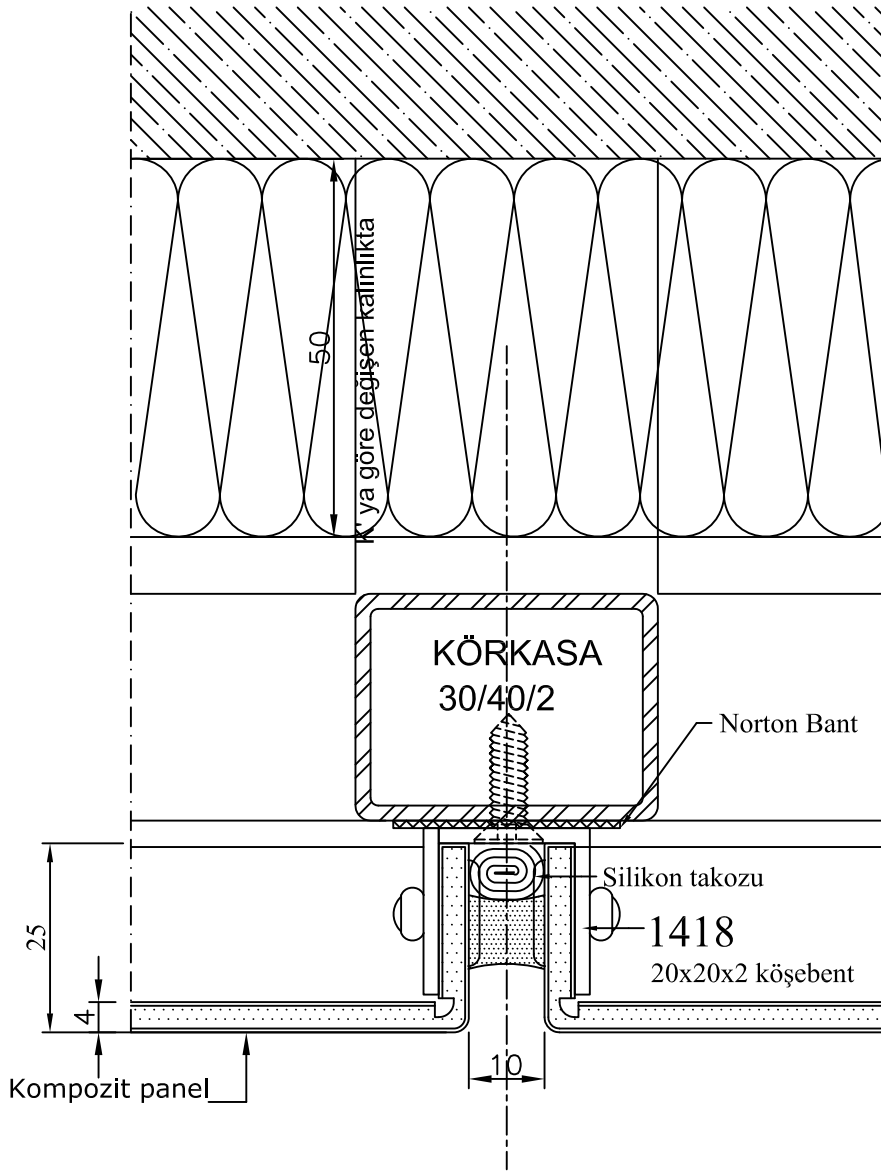
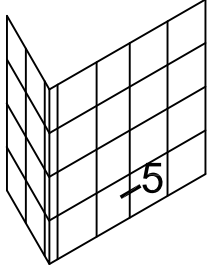

5 DETAYI

Kompozit Panel Cephe Kaplama Sistemi

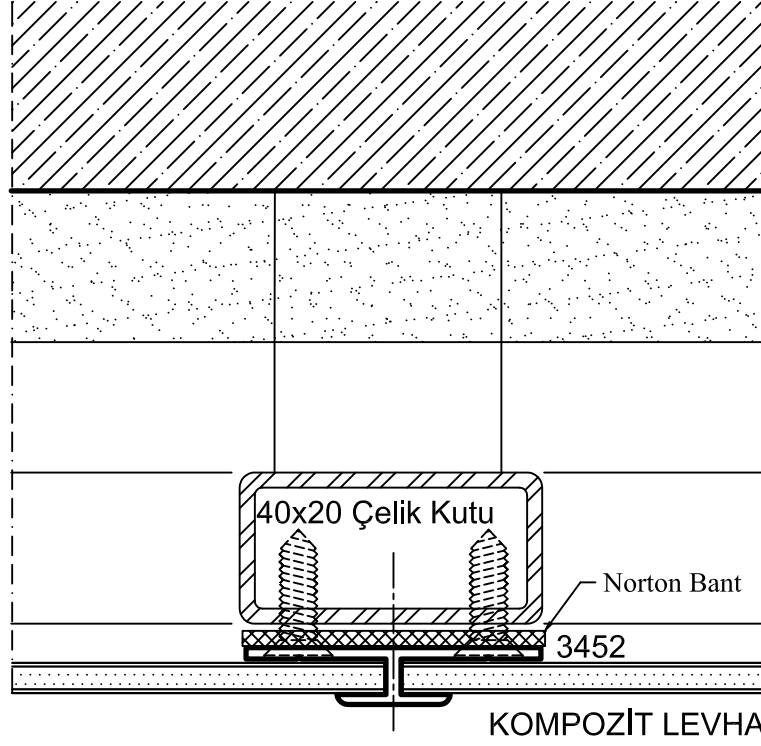
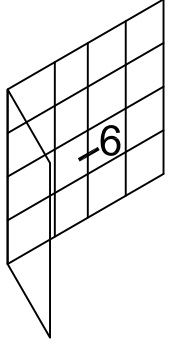

6 DETAYI

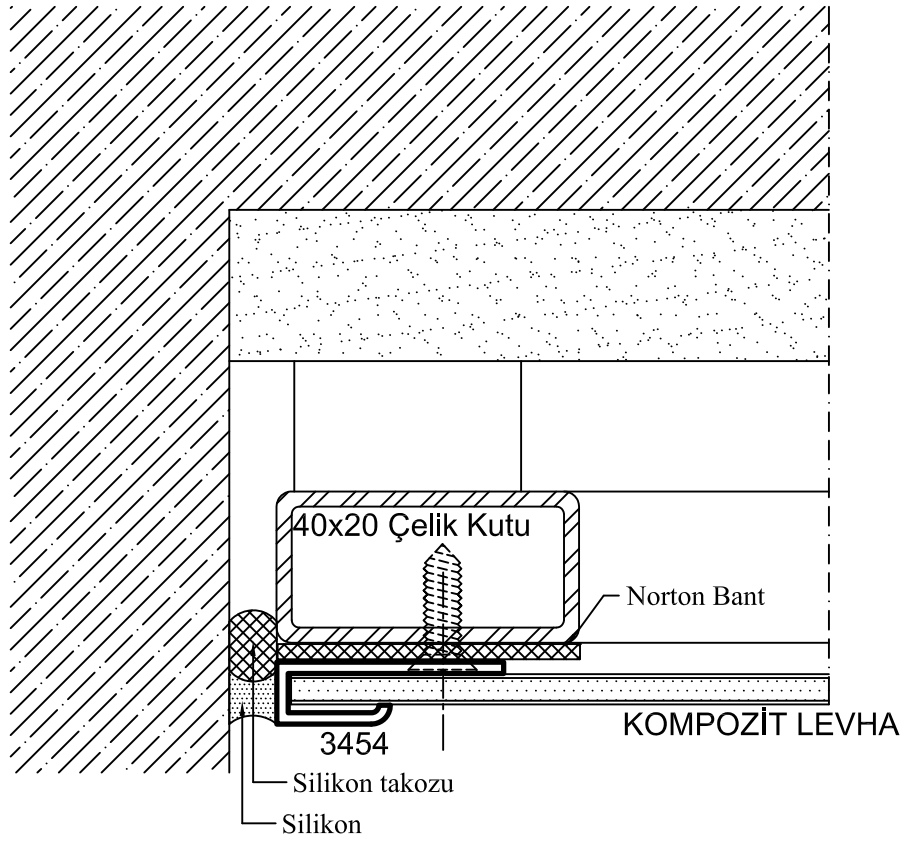
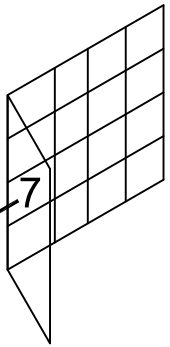

7 DETAYI